



Model
OSF

OSF

Above Grade Fiberglass Oil Water
Separator Systems 1 - 50 GPM

The OSF Series oil water separators are designed to remove oils and fuels from a wide variety of wastestreams where a variety of petroleum products mix with waterstreams.

The OSF Series, fiberglass oil water separators are a gravity/coalescing design for removal of free and finely dispersed oil droplets from various wastestreams.

The use of our proprietary Flopak, cross-corrugated, oleophilic coalescing media provides predictable oil removal through impingement coalescence while allowing solids settling without plugging.

Performance: 10 mg/L 30-micron free, dispersed and non-emulsified oil droplets.

The OS fiberglass design is one of 8 different oil water separator designs from Pan America Environmental that can be used singularly or in combination with other treatment processes such as emulsion cracking, DAF & clarifier pretreatment.

Full, turnkey stationary or mobile systems can be provided with many options and custom configurations can be provided tailored to the particular project requirements or wastestream needs.

5 OSF separator sizes are offered.

Features:

- ◆ Fiberglass construction
- ◆ Flopak coalescing media
- ◆ Adjustable oil skimmer
- ◆ Solids V-hopper
- ◆ Influent diffuser
- ◆ Sealed/gasketed cover
- ◆ Quick remove cover hardware
- ◆ Oil reservoir
- ◆ Water weir
- ◆ High performance
- ◆ Compact, simple design

Typical applications:

- ◆ Groundwater remediation
- ◆ Mobile separation system
- ◆ DAF/Clarifier pretreatment
- ◆ Power plant water treatment
- ◆ Refinery process water
- ◆ Aircraft wash racks
- ◆ Retrofit existing systems
- ◆ Tank farm leakage treatment
- ◆ Vehicle washwater treatment
- ◆ R.O. Filter pre-treatment
- ◆ Oil spill recovery
- ◆ Trench water treatment
- ◆ Bilge water treatment
- ◆ Hydraulic fluid tank de-watering



Model OSF

OSF
Fiberglass Oil Water Separator
Systems 1 - 50 GPM

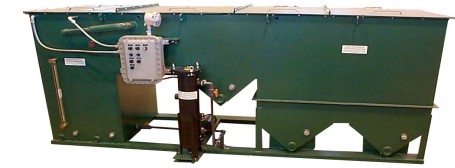
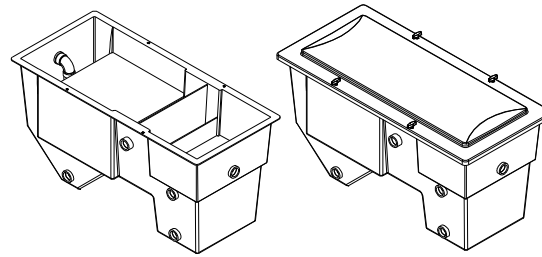

For larger flow rates see our OS and OSE Series steel separators

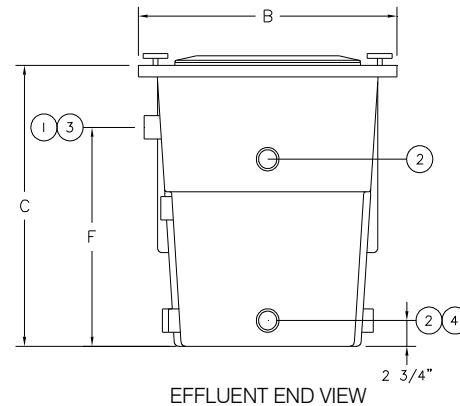
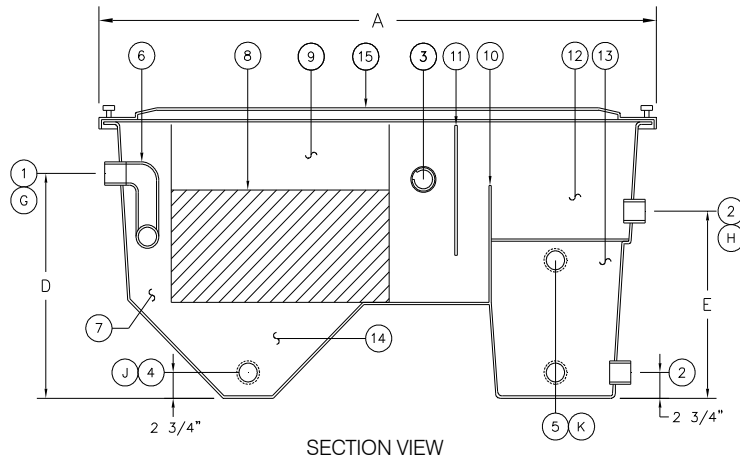

Available Tank Configurations

Standard tank configuration

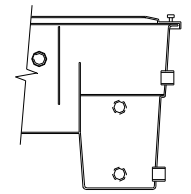

FIG. 1

Expanded effluent chamber

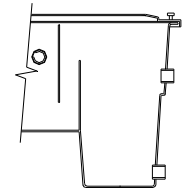

FIG. 2

Vertically split effluent/oil chambers

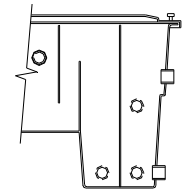

FIG. 3

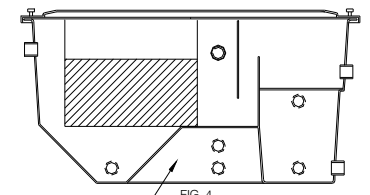

FIG. 4

Oil reservoir located under the separator

Model	Dimensions		Elevations			Fitting Sizes					Weight (Lbs)		Media Ft ²	Tank Vol. Gal.	Effluent Vol. Gal.	Oil Vol. Gal.	Sludge Gal.	GPM	
	A	B	C	D	E	F	G	H	I	J	K	Dry							Full
OS2F	5'-2"	1'-5"	2'-7"	2'-0"	1'-8"	1'-11"	2"	2"	2"	2"	2"	120	483	136	25	4	8	7	5
OS4F	5'-2"	2'-5"	2'-7"	2'-0"	1'-8"	1'-11"	2"	2"	2"	2"	2"	145	980	272	51	10	25	13	10
OS8F	6'-0"	2'-5"	3'-7"	3'-0"	2'-4"	3'-0"	2"	2"	2"	2"	2"	190	1810	544	125	15	40	13	25
OS12F	6'-0"	3'-4"	3'-7"	3'-0"	2'-4"	3'-0"	3"	3"	3"	2"	2"	375	2795	816	180	25	60	25	35
OS16F	6'-0"	4'-4"	3'-7"	3'-0"	2'-4"	3'-0"	3"	3"	3"	2"	2"	460	3730	1088	240	35	80	37	50

Item	QTY	Description	Item	QTY	Description	Item	QTY	Description	Item	QTY	Description	Item	QTY	Description
1	1	Inlet	4	2	Sludge Out	7	1	Inlet Chamber	10	1	Water Weir	13	1	Oil Storage
2	2	Outlet	5	2	Oil Outlet	8	1	Flopak Media	11	1	Oil Baffle	14	1	Sludge Hopper
3	1	Oil Outlet	6	1	Inlet Diffuser	9	1	Sep. Chamber	12	1	Outlet Chamber	15	1	Cover



2309 N. Ringwood Rd., Ste G
McHenry, IL 60050 USA
815.344.2960 Fax: 847.487.9218
panam@panamenv.com

www.panamenv.com
www.oil-water-separator.net
www.oil-separator-media.com

Oil Water Separator Options Descriptions

Influent Feed System Air operated, diaphragm pump with air controls, progressive cavity or hose pump, sump level switches & Nema 4 control panel, base mounted, 115/230/460V power offered. Electric diaphragm pumps available in limited sizes.

Effluent Pumpout Centrifugal pump with level switches & Nema 4 control panel, base mounted, 115/230/460V power offered. OS Effluent chamber must be expanded to accommodate pumpout or provision of an external pumpout tank.

Sludge Pumpout System Air operated, diaphragm pump with air controls & Nema 4 control panel, auto on/off timer, base mounted, 115V/1ph/60Hz power req'd. Progressive cavity pump system also available. 1 - 100 GPM.

Oil Pumpout System Air operated, diaphragm pump with air controls, level switches & Nema 4 control panel, base mounted, 115V/1ph/60Hz power req'd. Electric gear or progressive pump systems available. 1 - 100 GPM (larger if required)

Anchor Brackets L-brackets are provided bonded to the tank for bolting the tank to your mounting surface.

Freeze Protection Immersion heaters mounted through tank wall. Each heater has an independent thermocouple well, 0-100 deg. F thermostat and Nema 1 (or optional Nema 4) housing. 115/230/460V/1-3ph/60Hz power req'd.

Retpak Secondary Coalescer High surface area, reticulated, secondary coalescing media for polishing flow after standard Flopak media.

Oil Sight Glass Two automatic, brass valves with tempered sight glass and protection rods mounted in oil reservoir. If glass is broken check ball stops outflow from reservoir.

External Sight / Level Glass An externally mounted clear PVC sight tube is provided with multi-point level switch for indication or pump control of oil or water. Switch is removable for cleaning and inspection.

Elevation Stand Epoxy coated steel stand or legs to elevate tank to desired level. Standard deck height is 30".

Full platforms & walkways with ladders or stairways can be designed where required or desired.

High Temperature Design Flopak coalescing media and any piping is constructed of a combination of CPVC &/or polypropylene (or other materials) for temperature resistance up to 200° F.

Alternate Media Construction Standard Flopak media is PVC. HPVC, polypropylene, glass-coupled polypropylene and 304/316 stainless media is available. Contact PAE to determine proper media type for your application. Media plate spacing is available in 1/2", 3/4" & 1.2".

External Storage/Feed Tanks A wide variety of tank volumes can be supplied for your water, product and sludge holding needs. Flat bottom and cone bottom designs constructed in polyethylene, fiberglass, steel & stainless steel can be provided.

Effluent Filter Systems Solids filter systems can be provided to remove filterable solids from the separator effluent. Contact Pan America to determine proper filtration needs for your application.

AQAM Filter Systems AQAM (Alkyl Quaternary Ammonium Montmorillonite) filter systems can be provided to remove trace hydrocarbons, sheens, DNAPL, slightly soluble chlorinated hydrocarbons and high molecular weight organics from the separator effluent. Contact Pan America to determine proper filtration needs for your application. Can be used to protect and increase GAC lifespan.

Carbon Filtration Systems (GAC) GAC carbon filters can be provided to remove contaminants after the separator. Contact Pan America to determine proper system needs for your application.

Emulsion Cracking Systems Emulsion cracking systems can be provided to remove oil-in-water emulsions prior to the separator. Contact Pan America to determine proper system needs for your application.

pH Adjustment Systems pH adjustment systems can be provided to maintain pH levels prior to or after the separator. Contact Pan America to determine proper system needs for your application.

System Containerization OS separators with any options can be installed in a 20 or 40' shipping container(s) to simplify system provision and field implementation.

System would include the complete mounting, piping and wiring of the system in one or more container as required by the project.

Trailer Mounting OS separators can be mounted on a trailer for system mobilization. Trailer design generally includes corner leveling jacks, bubble levels, walkway, toolbox, electric or hydraulic brakes, piping and wiring of options.

Field Skid Mounting OS separator system can be mounted to a mobile skid with leveling for quick field mobilization.

Skid Mounted System OS separators can be combined with our other treatment equipment and options into a fully integrated, custom designed system completely mounted, plumbed and wired to a system skid. To simplify your need to do the wiring and plumbing on site, reducing your time frames and on site costs, we design around your requirements.

Vent Scrubber Separator vapors can be extracted and scrubbed prior to discharge to atmosphere to remove VOC content.

Level Sensors Level sensors can be provided to detect water and oil/fuels. One or more sensor points can be provided to perform various functions such as high level, low level, pump on/off based on liquid levels and level detection for DCS controls or other functions based on your needs.

Class 1 Div 1 & 2 Systems can be designed for use in a class 1 div 1 or 2 environment. Controls, components and wiring are changed to meet the needs of these environments. Intrinsically safe relays are also used for level sensors.

Oil Monitor An oil detection system can be provided to monitor effluent oil content and provide various actions based on the oil alarm setpoint. Actions might include: audible/visual alarm, redirection of influent or effluent via actuated valve, shutdown of influent pump or your custom action.



www.panamenv.com

2309 N. Ringwood Rd., Ste G McHenry, IL 60050 USA
815.344.2960 fax: 847.487.9218
panam@panamenv.com

OS Series Fiberglass Oil/Water Separator Engineering Specification OS2 through OS16

Section 1.0 Equipment Design & Construction

Performance

The Pan America Environmental OS Series Oil/Water Separators are designed to produce an effluent concentration of 10 mg/l or less of oil droplets 30 micron and larger of non-emulsified, free and dispersed oils. By virtue of our Flopak coalescing media and tank designs readily settleable solids are also removed.

1.01 Design

The oil/water separator will be designed and fabricated per the following specifications. Rectangular tankage with features as described designed per API #421 Design & Operation of Oil/Water Separators Manual, February 1990 and Stokes law. The design will incorporate flexible flow rating capability based on application parameters.

1.02 Influent Chamber

Influent flow enters the clog-proof influent diffuser pipe and is immediately spread out across the depth and width of the chamber. Any readily settleable solids drop to the bottom of the V-shaped solids accumulation chamber located directly under the coalescing media bundle.

1.03 Oil/Water Separation Chamber

The separation chamber is to be packed with Flopak cross-fluted coalescing media. The media pack will be designed to create a quiescent zone, a laminar flow pattern to facilitate the impingement of oil on the media, and will provide numerous impact sites and changes of flow direction. The media shall have a 60-degree cross-flute angle.

1.04 Cylindrical Oil Skimmer

The separator shall be provided with an adjustable cylindrical oil skimmer that allows the skim head to be readily removed or adjusted. The skim head rotation collar assembly will be provided with a Buna-N seal. The oil skimmer is to be located at the effluent end of the separation chamber. The skimmer shall not require lubrication for operation.

1.05 Solids Accumulation Chamber

The separator shall have a V-shaped solids accumulation chamber located under the coalescing media. This chamber will provide temporary solids storage. The chamber walls are to be pitched at 45 degrees to assure simple and thorough solids removal. Dual outlet ports will be provided for sludge removal.

1.06 Clean Water Effluent Chamber

The cleansed water will flow under the oil baffle, over the water weir and into the effluent chamber. This chamber is to have the capability to be expanded at the factory or at the jobsite by modifying the standard integral oil reservoir so a greater volume of water is available for pump suction directly from the OS tank.

1.07 Oil Reservoir

An integral oil reservoir is to be provided for the temporary storage of separated oils. This chamber is located at the effluent end of the separator. The reservoir will have fittings for pump suction, high/low level switch accommodation, vent and optional sight glass installation.

1.08 Separator Cover

The separator is to have a single piece cover that provides complete closure of the tank. The separator cover will be mounted to the tank via quick release hardware and vapor sealed with an industrial grade closed cell, "D" shaped compressible EPDM gasket.

1.09 Fittings

All wetted fittings must be fiberglass constructed, integrally bonded via fiberglass bond to the tank for permanent, leak proof fitting seal. Tank penetrating, gasketed, plastic bulkhead fittings or couplings are not to be used. Standard fittings are FNPT coupling.

Section 2.0 Materials of Construction

2.01 Fiberglass Construction

Tank shell, baffles and cover shall be molded of premium grade DION 6694 high cross-link density FRP/resin composite utilizing mat and chopped roving construction with a minimum of 25% chopped fiberglass fiber to resin mix. An ultraviolet stabilized gel coat shall be used to coat external surfaces 16-20 mils dft. Finish color to be white.

2.02 Piping

Internal piping shall be type 1, grade 1, ASTM 1785 PVC.

2.03 Coalescing Media

Flopak, cross-fluted, oleophilic, PVC construction, coalescing media shall be provided as manufactured by Pan America Environmental, Inc.

2.04 Cover Gasketing

Closed cell, industrial grade, "D" shaped, EPDM constructed vapor sealing cover gasketing shall be provided. No neoprene shall be permitted.

2.05 Manufacturer

The manufacturer of preference shall be: Pan America Environmental, Inc.

2.06 Warranty

Pan America Environmental warrants its products to be free of defect in materials and workmanship for a period of one year from the date of shipment.



www.panamenv.com

2309 N. Ringwood Rd., Ste G McHenry, IL 60050 USA
815.344.2960 fax: 847.487.9218
panam@panamenv.com

BULLETIN: OSF OIL WATER SEPARATOR FIBERGLASS.PDF

©1991-2019 Pan America Environmental, Inc.